

INSTRUCTION MANUAL

YC - 355 D

YAESU MUSEN CO., LTD.

TOKYO JAPAN.

FREQUENCY COUNTER

YC-355D

GENERAL

Yaesu Model YC-355D, frequency counter is of compact design, light weight and completely self-contained instrument, using advanced I.C. techniques to enable counting of a wide frequency range 5 Hz to 200 MHz.

Dual range system provides 8 digit measurement with MHz or kHz indications. Double-sided epoxy circuit board helps to

ensure stable and accurate service for many years. Dual power supply incorporates a high efficiency "C" core transformer. An added feature is the ability to operate on a wide range of AC line voltages 100/110/117/200/220/234V 50/60Hz, or on 12V DC with built-in DC-DC converter.

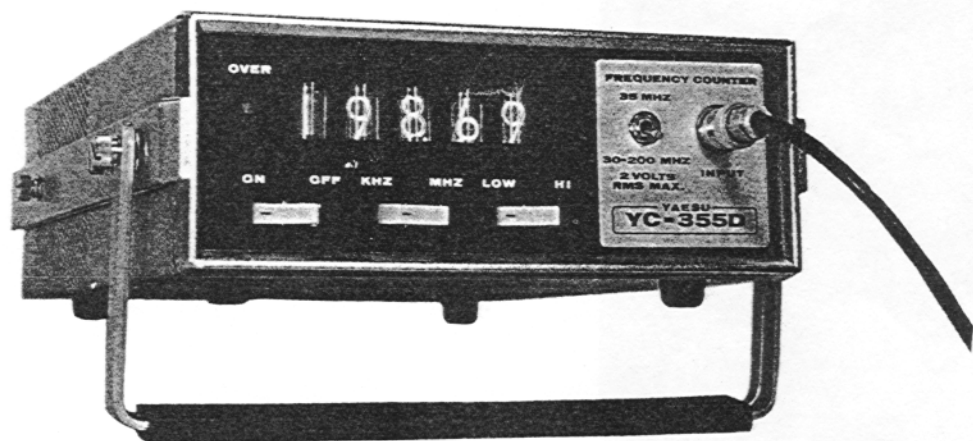

SPECIFICATIONS

Frequency range	: 5Hz-35MHz, 30-200MHz selectable
Accuracy	: \pm time base stability+1 count
Number of digits	: 5 digits
Gate time	: 1milli-sec. or 1sec.
Indicating time	: 0.1sec. or 1sec.
Display units	: kHz and MHz
Input voltage * 1)	: 20mV-20V p-p continuous 60V p-p for 10 sec.
Input impedance	: 1M ohm/50 ohm
Input capacitance	: less than 20 pf
Clock crystal	: 1.000MHz
Stability	: \pm 0.0005% at 25°C \pm 0.0025% 0°C-40°C
Aux. 1 MHz output	: 5V p-p approx
Operating temp.	: 0°C-40°C (approx. 30°F-90°F)
Power requirements	: [A.C.] 100/110/117/200/220/234V 50/60Hz 18VA. [D.C.] 12-14.5V 1A
Dimensions	: 220W×80H×270D mm
Weight	: 3.5kgm (8lbs)
Tube & semi-conductors	: I.C. 26 Silicon transistor 9 F.E.T. 1 Diode 12 Display tube 5

* Specifications subject to change without notice.

* 1) 0.5-2V r.m.s. in the range of 30-200MHz.

PARTS LIST

Parts	Function	Type	Qty.
Tube	display tube	B5870S	5
Diode	regulator	1S993	1
	input	1S1555	4
	HT rectifier	1S1944	4
	LT rect. & DC protection	V06B	3
	Transistor	input amp.	2SK19GR
regulator		2SC828P	1
"		2SC735Y	1
input amp.		2SC1047C	2
over-range neon driver		2SC869C	1
reg. & DC to DC conv.		2SD317Q	3
buffer amp.		2SC536D	1
I.C.		SN7400N	2
		SN7404N	1
		SN7441N	5
		SN7473N	1
		SN7475N	5
		SN7490N	11
	MS3380	1	
Neon	over-range indicators		1

ACCESSORIES

- * A.C. Power cord with 4 pin screw on plug (2 meter long)
- * D.C. Power cord with 4 pin screw on plug (2 meter long)
- * Signal test lead 1 meter long with BNC connector and clips
- * 1A fuse for A.C. (1)
- * 2A fuse for D.C. (1)

REAR PANEL FUNCTIONS

POWER CONNECTOR

This socket accepts the plug on either the A.C. or D.C. leads.

AC/DC SWITCH

Selects operating voltage-AC or DC. The set is not damaged if the switch is set in the wrong position and power is applied.

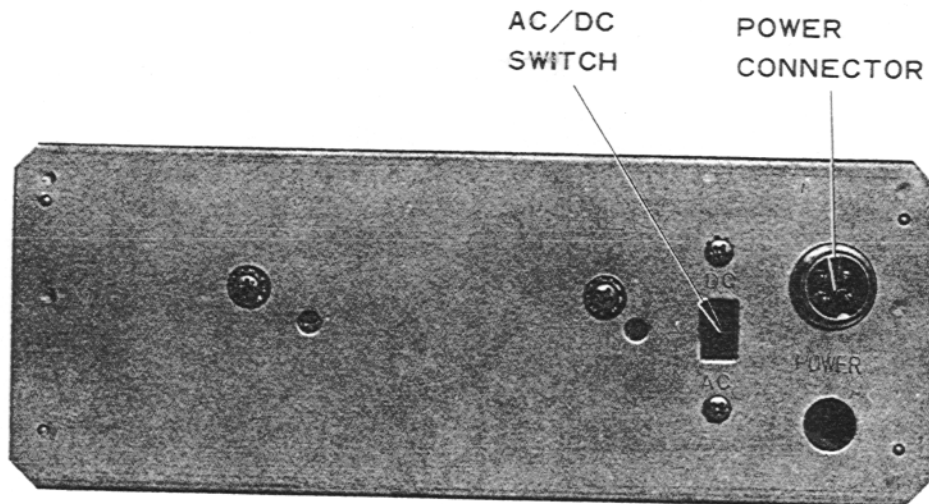

FRONT PANEL CONTROLS

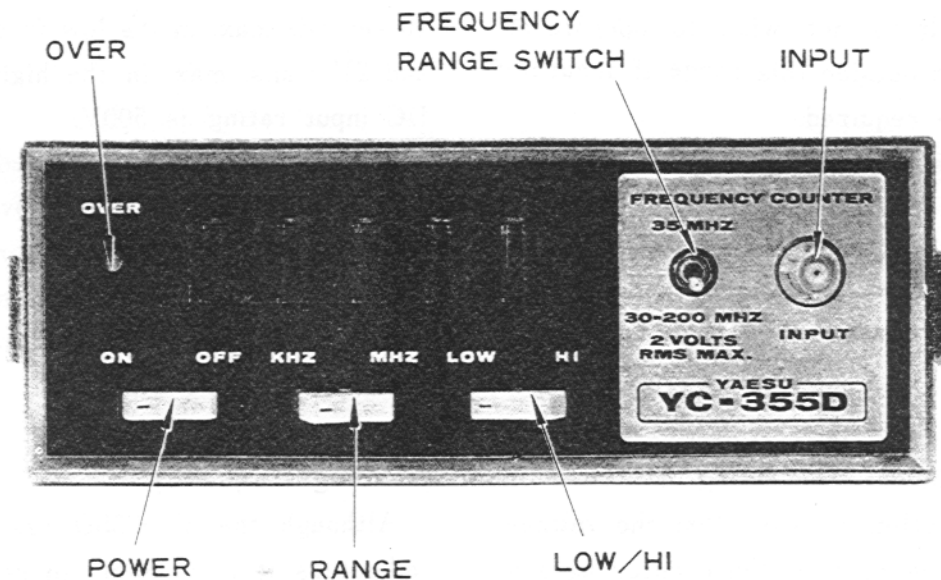

OVER

This is an over range indicator which will flash on when the input frequency is above 100 kHz when the range switch is in the KHZ position.

POWER

Power on/off switch functions on A.C. and D.C.

RANGE

The frequency range switch should normally be at KHZ for frequencies below 99.999 kHz and at MHZ for frequencies above 100 kHz. In the KHZ position the digits to the left of the decimal point are kHz and to

the right Hz. In the MHZ position the digits to the left of the decimal point are MHz and to the right kHz.

LOW/HI

This switch selects the input impedance of the counter.

LOW 50 ohm

HI 1Mohm

INPUT

BNC connector accepts the plug on the test lead.

FREQUENCY RANGE SWITCH

This switch selects the frequency ranges of 5 Hz—35 MHz and 30—200 MHz.

OPERATION

The frequency counter is designed to operate at temperatures between 30°F-90°F (0°-40°C). It is not wise to operate at temperatures outside this range if accurate readings are required.

Do not use the counter in bright sunlight, even if the ambient temperature is within this range.

The YC-355D may be operated from 100/110/117/200/220/234 volts AC when appropriately wired but is normally supplied for 117 volts AC and 12 volt DC operation. Therefore, before connecting AC cord to the power outlet, be sure that the voltage marked on the rear of the counter agrees with the local AC supply voltage. For DC, below 11 volts operation will be unstable and above 14.5 volts damage to the transistor may result.

CAUTION

PERMANENT DAMAGE WILL RESULT IF IMPROPER AC SUPPLY VOLTAGE IS APPLIED TO THE COUNTER.

Frequency measurement

Before plugging into power source make sure that the power switch is off and that the power selector AC/DC is in the correct position.

When the power is turned on, the numeric display should show 5 zeros.

Connect the measuring cable to the input connector and attach clip leads to the measuring point; black is ground. Select the appropriate input impedance and frequency range.

The maximum input voltage is 20V p-p for continuous operation and 60V p-p for 10 seconds max. in the low frequency range and 2V r.m.s. max. in the high range. The DC input rating is 500V.

If the signal to be measured has an amplitude greater than the above mentioned value, use an attenuator for continuous operation. If the DC component exceeds 500V use a high voltage capacitor of 0.01 uF in series with input.

Reading frequency

Although the YC-355D has 5 numerical indicators it is possible to read to 8 digit accuracy.

If the counter is on the MHZ range and the indicators show 12.346 MHz, then the actual frequency is between 12.345 and 12.346. If the range switch is set to KHZ then the next 3 digits can be read off, e.g. it may now show 45.678 kHz. Then the actual frequency is 12.345678 MHz, however the last digit will be one count in error, i.e. the last digit is either 7 or 8. Refer to Fig.1.

Input impedance

The input impedance can be changed by a switch on front panel to minimise the effect of the counter on the circuit measured. HI position may be used to minimise the loading on the circuit and LOW position may be used to minimise stray pick up. For 30-200 MHz range, HI position must be used.

Over range lamp

The over range lamp will flash on and off if the input frequency is greater than 100 kHz when operating in the KHz position. No damage will be done if the counter is

operated continuously under over range conditions, the lamp merely indicates that the true frequency is not being fully displayed but may lack the first 3 digits.

Measuring distorted waveforms

If the signal to be measured has some harmonic content, then depending on the input level the counter may show the fundamental or the harmonic frequency.

Error

When measuring frequency with a frequency counter there are always errors inherent in the system which cannot be avoided.

There are two possible sources of error:

- (1) Standard marker generator error.
- (2) Counting error associated with the input gate.

The first error results when the frequency of the marker generator crystal changes due to temperature or aging. The counter operates by counting the number of pulses of the input signal which passes through the gate for a set period of time. In this counter gating time is 1 milli sec and 1 sec, which is controlled by the 1 MHz crystal. If the crystal frequency increases by 1%, the gate time is reduced by 1% which causes a -1% error in indicated frequency.

In the YC-355D the crystal accuracy is $\pm 0.0025\%$ which represents an error of ± 750 Hz at 30 MHz. (But, on normal temp., about 1/5 of this error (± 150 Hz)).

The second error is always present and is called as one count error. This error results when the gate opens just before a pulse or just after a pulse and causes an error of +1.

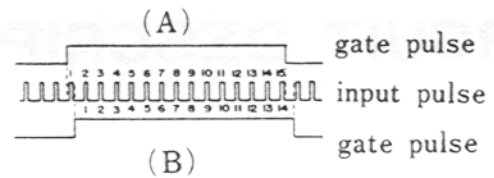

Fig. 1

Because the counter counts the number of pulses that pass through the gate then if the gate opens as in the top drawing (A) the counter will count 15 pulses. If it opens as in the bottom drawing (B) it will count 14 pulses, although the frequency is the same.

The last digit only has this error, hence on the YC-355D the error is +1 Hz on the KHz range and +1 kHz on the MHz range.

This error must be considered when measured frequencies only occupy the first two digits on either range.

CIRCUIT DESCRIPTION

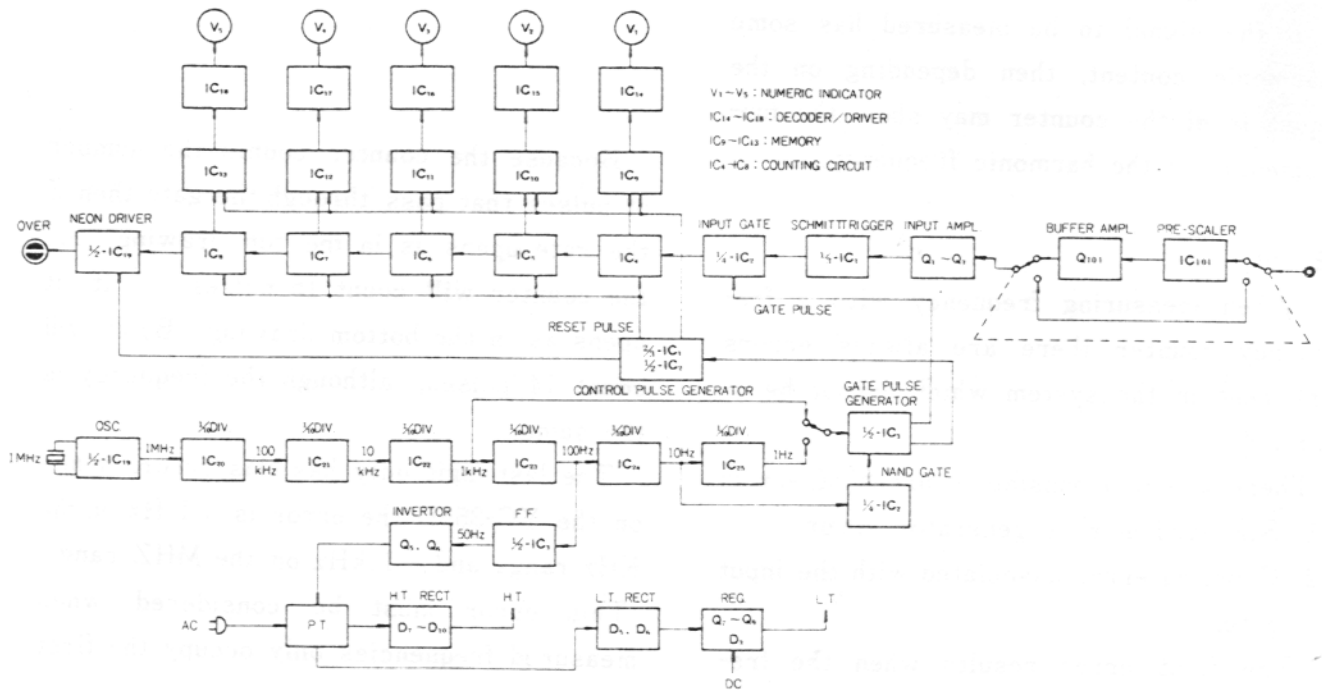

V₁-V₅ : NUMERIC INDICATOR
 IC₁₄-IC₁₈ : DECODER/DRIVER
 IC₉-IC₁₃ : MEMORY
 IC₄-IC₈ : COUNTING CIRCUIT

BLOCK DIAGRAM

- | | | | |
|---|---|---|-------------------------------------|
| V ₁ -V ₅ | : numeric indicator tubes | 1/2 IC ₁₉ | : 1 MHz crystal oscillator |
| IC ₁₄ -IC ₁₈ | : drivers for V ₁ -V ₅ , binary coded number change to decimal number | IC ₂₀ -IC ₂₅ | : clock divider chain $\div 10^6$ |
| IC ₉ -IC ₁₃ | : memory | 1/4 IC ₂ | : NAND gate |
| IC ₄ -IC ₈ | : counting circuits | 1/2 IC ₃ | : $\div 2$ flip flop |
| 1/2 IC ₁₉ Q ₄ | : over range neon driver | Q ₅ , Q ₆ | : power supply inverter transistors |
| Q ₁ -Q ₃ | : input amplifier | D ₇ , D ₁₀ | : HT rectifiers |
| 1/3 IC ₁ | : schmitt trigger | D ₅ , D ₆ | : LT rectifiers |
| 1/4 IC ₂ | : input gate | Q ₇ -Q ₉ , D ₃ | : LT regulator |
| 2/3 IC ₁ , 1/2 IC ₂ | : control pulse generator | Q ₁₀₁ | : buffer amplifier |
| 1/2 IC ₃ | : gate pulse generator | IC ₁₀₁ | : pre-scaler |

The input signal is fed directly or through the pre-scaler unit where the signal is divided by ten, to transistors Q1, Q2 and Q3 which form a high input impedance amplifier having a frequency response from 5 Hz-45 MHz.

Because the IC's in the counting chain require a square wave drive pulse to function reliably, the output of the input amplifier is fed to a schmitt trigger. This converts the input waveform regardless of waveform into a square wave of constant amplitude.

The output of the schmitt trigger is then fed to the gate circuit composed of 1/4-IC2, the gate is open for 1 sec on the KHZ range and 1 milli-sec on the MHZ range.

IC4-IC8 form the counter which counts the number of pulses passing through the gate. Each IC counts to 10 and then starts again automatically. The output of each IC is in binary coded decimal, and each time one IC counts to 10, it feeds one pulse to the next IC. Thus with 5 IC's it is possible to count to 10^5 .

Each IC in the counting chain (IC4-IC8) has four output terminals, each representing a particular binary code number-1, 2, 4, 8, and combinations of these numbers indicate the count between 0 and 9.

Thus from the table, 9 is composed of one 8 and one 1. Also the decimal number 7 (0111) is represented by one 4, one 2 and one 1.

The binary coded decimal output from IC4-IC8 is fed to IC9-IC13 which are buffers and also perform the memory function. The memory is required to prevent the numeric indicators from following each count when the gate opens. The result is that the frequency measured in one count is held in

Decimal Number	Binary coded number			
	Possible logic combinations at the 4 output of each counting IC.			
	A	B	C	D
0	0	0	0	0
1	0	0	0	1
2	0	0	1	0
3	0	0	1	1
4	0	1	0	0
5	0	1	0	1
6	0	1	1	0
7	0	1	1	1
8	1	0	0	0
9	1	0	0	1
	8	4	2	1

the indicators while the next count is being made, then they change when the count is completed.

The outputs from IC9-IC13 (still binary coded decimal) is fed to IC14-IC18 which convert the B.C.D. into decimal numbers and select the necessary cathode in the indicator tubes to show a particular number.

If the number of pulses passing through the gate is greater than 10^5 then this exceeds the counting capacity of the count circuit. The overflow from IC8 is fed to 1/2-IC19 and Q4 which form the over range indicator circuit. This circuit turns the neon on for approx. 200 millisecc and is reset before the next count.

The standard time oscillator (clock) is composed of the 1 MHz crystal oscillator 1/2-IC19 and IC20-IC25 divider chain. The divider chain is the same as the counting chain except that only the divide by 10 facility is used. This chain uses 6 IC's with a total division of 10^6 . Outputs are taken of at 1 milli sec (1 kHz), 10 milli sec (100 Hz), 100 milli sec (10 Mz) and 1 sec (1 Mz).

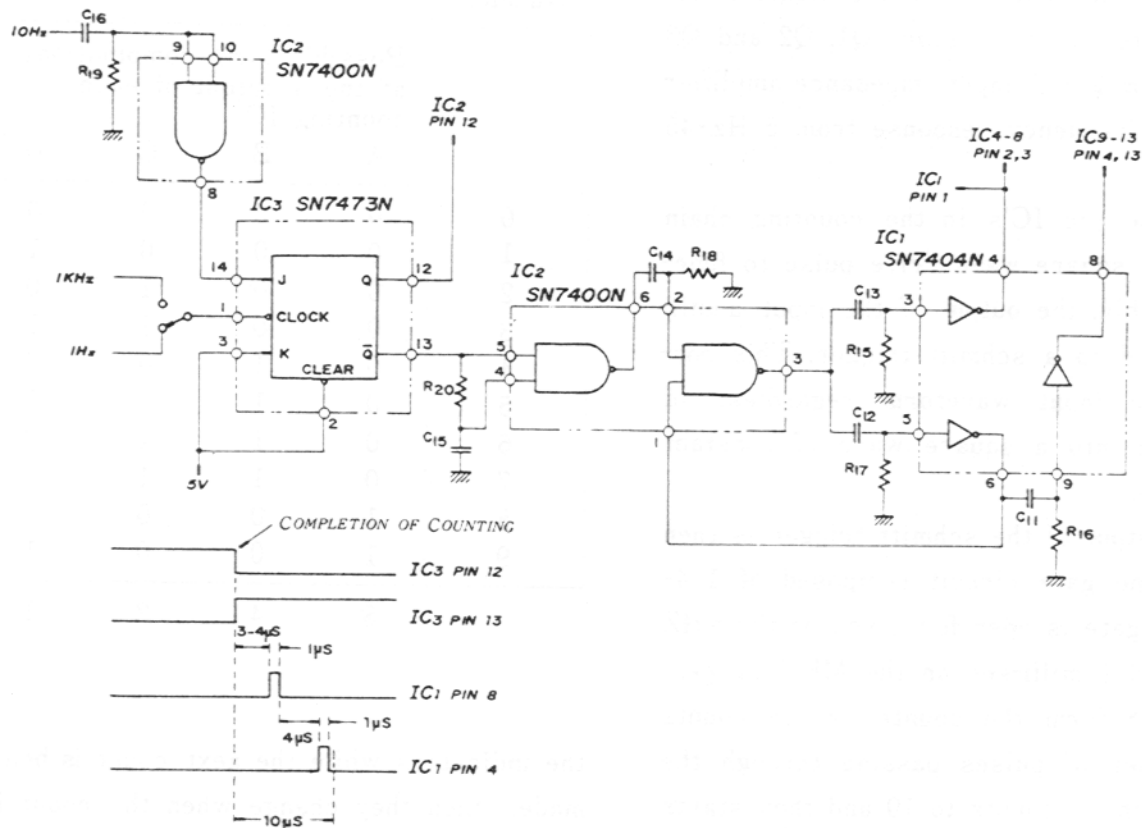

The pulse generator is composed of 1/4-IC₂, 1/2-IC₃ and 2/3-IC₁, 1/2-IC₂ generates pulses to reset the counting IC's, to control the memory and to open the input gate. Refer to the diagram to aid explanation.

The range switch selects the drive frequency from the standard time generator which is fed to the clock input of IC₃. The output from pin 12 is either pulses of 1 milli sec width or 1 sec width which open the gate in IC₂. However in the MHZ position the gate is opened 500 times every second, thus the display would change 500 times per second. This would make it difficult to read the last few digits especially.

This problem is overcome by feeding the 10 Hz clock signal through the inverter IC₂ and into the J input of IC₃. This limits the count rate to one every 100 milli sec while still maintaining a count time of 1 milli sec on the MHZ range.

The pulse from pin 13 of IC₃ is fed to IC₂ and IC₁ which produce pulses for the following purposes.

Approximately 4 micro-sec after a count is completed a pulse 1 micro-sec wide appears at pin 8 of IC₁, this pulse is fed to the memory IC's (IC₉₋₁₃). The pulse opens the memory for 1 micro-sec during which time, the value of the count is stored and fed to the indicators.

4 micro-sec after the completion of this pulse, another 1 micro-sec pulse, appears at pin 4 of IC₁. This pulse is fed to IC₄₋₈ which clears the counting IC's ready for the next count.

Power Supply

On A.C., the 9.5V winding is rectified and filtered and then regulated to supply 5V to the IC's. The 190V winding is rectified and filtered and supplies approx. 210V for the neons and indicator tubes.

On D.C., the 12V is fed to the LT regulator to provide 5V for the IC's. The 100 Hz output from IC₂₃ is fed to 1/2-IC₃ where it is divided by two, producing a 50 Hz push-pull drive for Q5 and Q6. These transistors in turn drive the 9.5-0-9.5 winding to produce the HT for the indicator tubes.

MAINTENANCE

It is recommended that all IC's be replaced by types of the same make as those used in the counter. The IC used for IC₄ should be selected for satisfactory operation up to 30 MHz because not all IC's will work satisfactorily.

Substitution for the other parts is permissible providing device ratings and characteristics are matched. The crystal is specially made for the counter and substitution should not be made.

Transistor Voltages

measured with V.T.V.M., counter operating on A.C.

	Q1	Q2	Q3	Q4	Q5	Q6	Q7	Q8	Q9
Col/ Drain	4.35	3.35	2.65	0	0	0	6.5	8	8
Base/ Gate	0	1.2	1.5	0.65	0.35	0.35	3.8	5.8	6.5
Emit/ Source	1.25	0.45	0.75	0	0	0	3.2	5.0	5.8

for any given unit values should be within $\pm 20\%$.

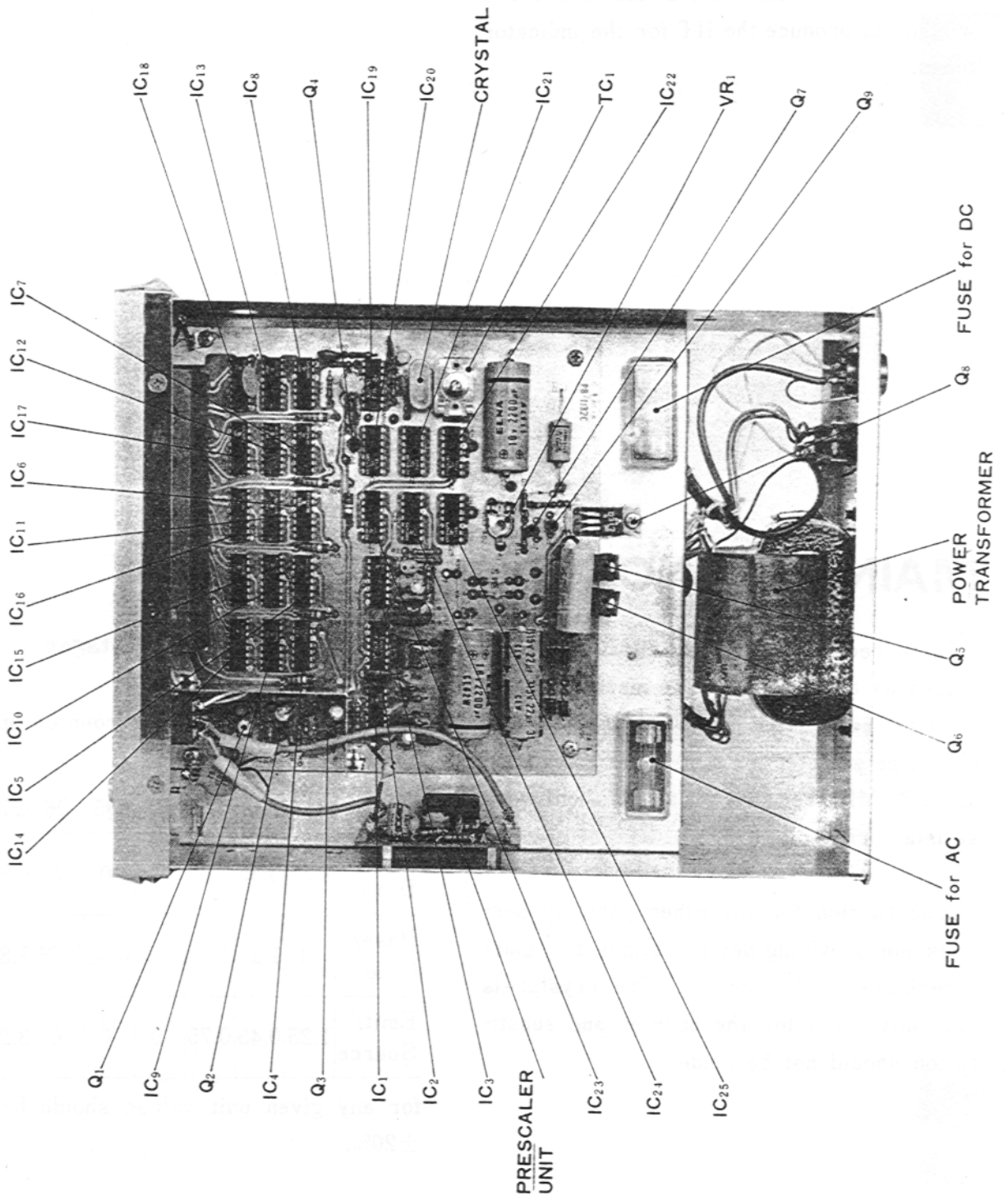

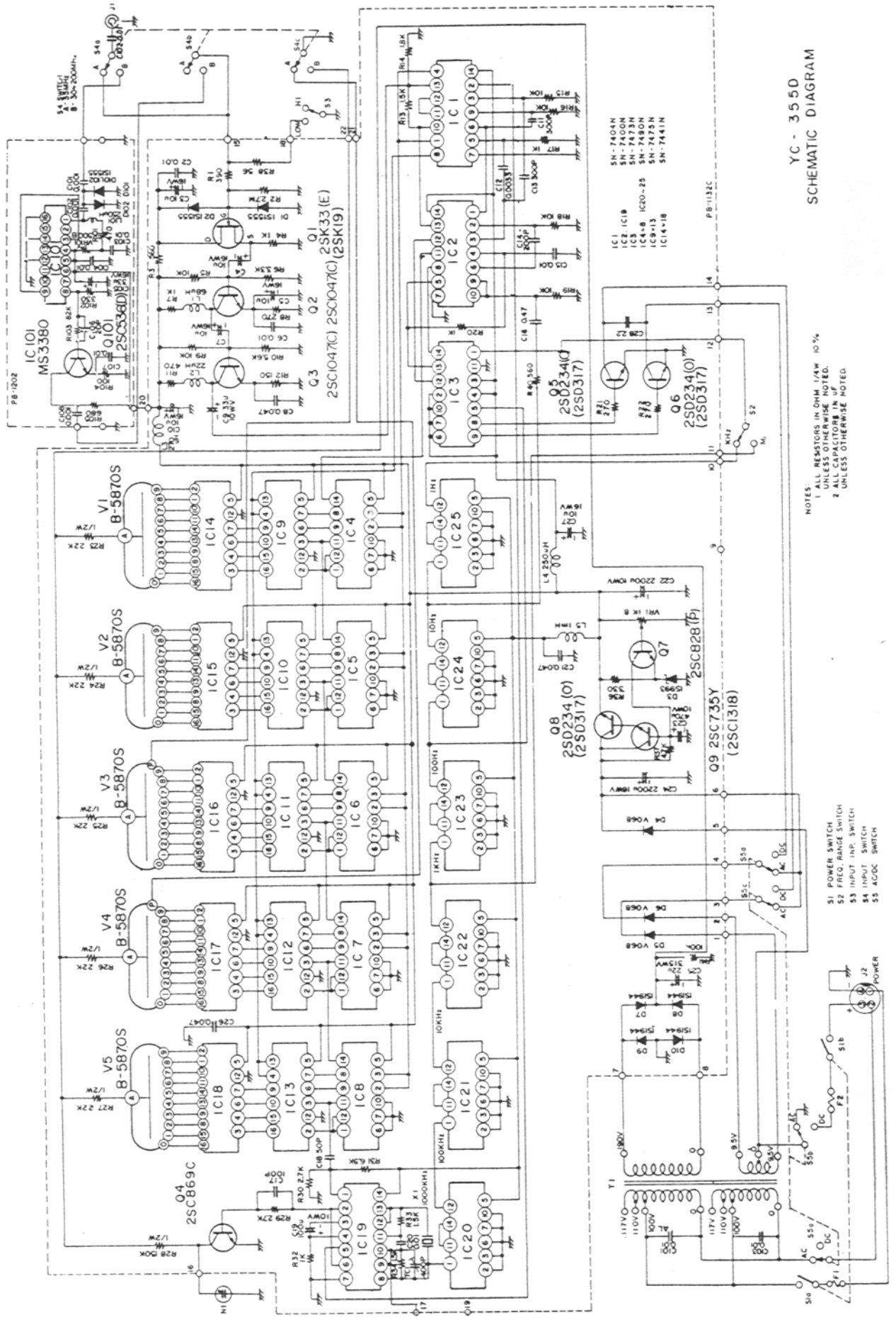

YC - 3550
SCHEMATIC DIAGRAM

NOTES:
1 ALL RESISTORS IN OHM 1/4W 10%
2 ALL CAPACITORS IN µF
UNLESS OTHERWISE NOTED.
UNLESS OTHERWISE NOTED.

- S1 POWER SWITCH
- S2 FREQ. RANGE SWITCH
- S3 INPUT SW. SWITCH
- S4 INPUT SWITCH
- S5 AC/DC SWITCH

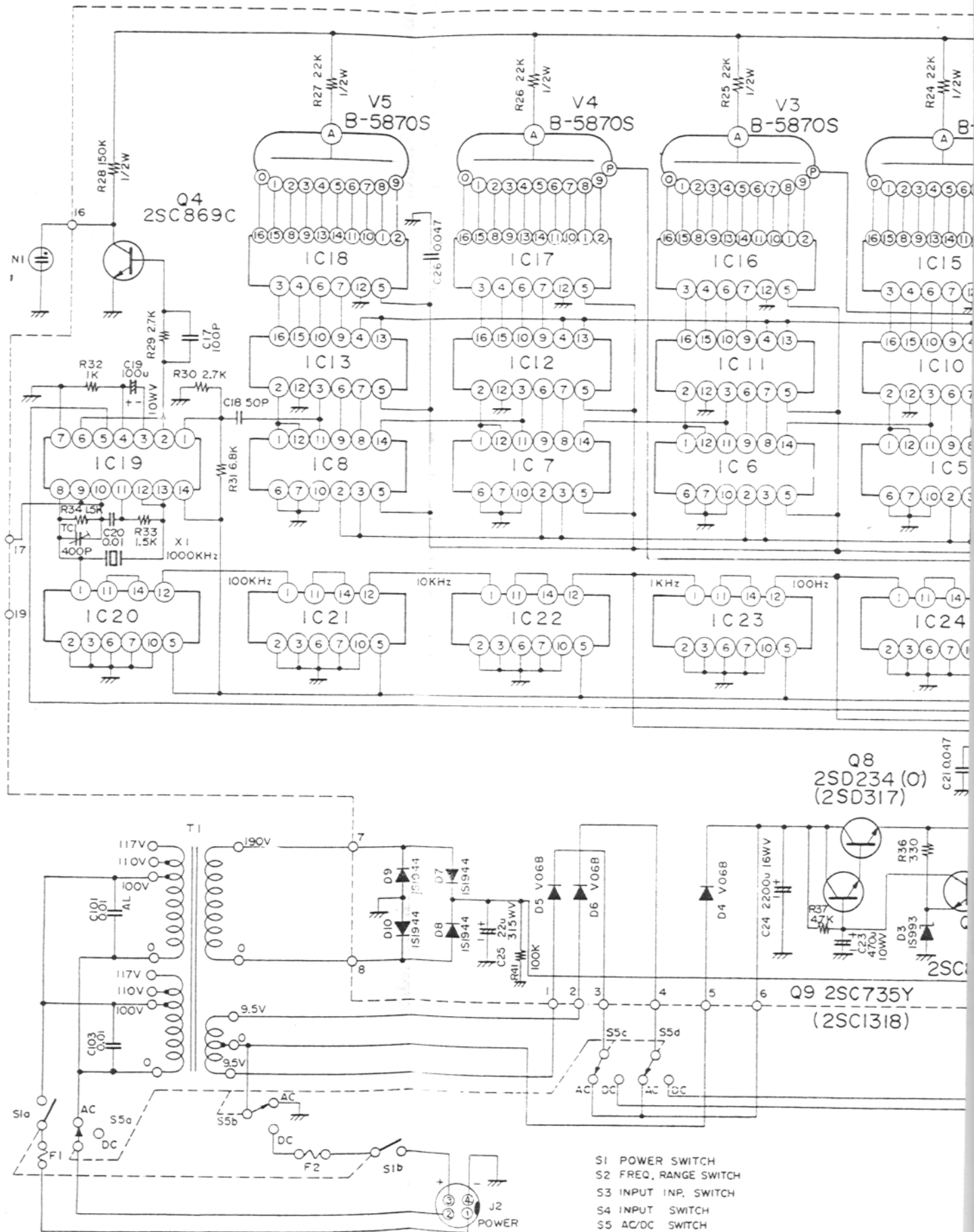

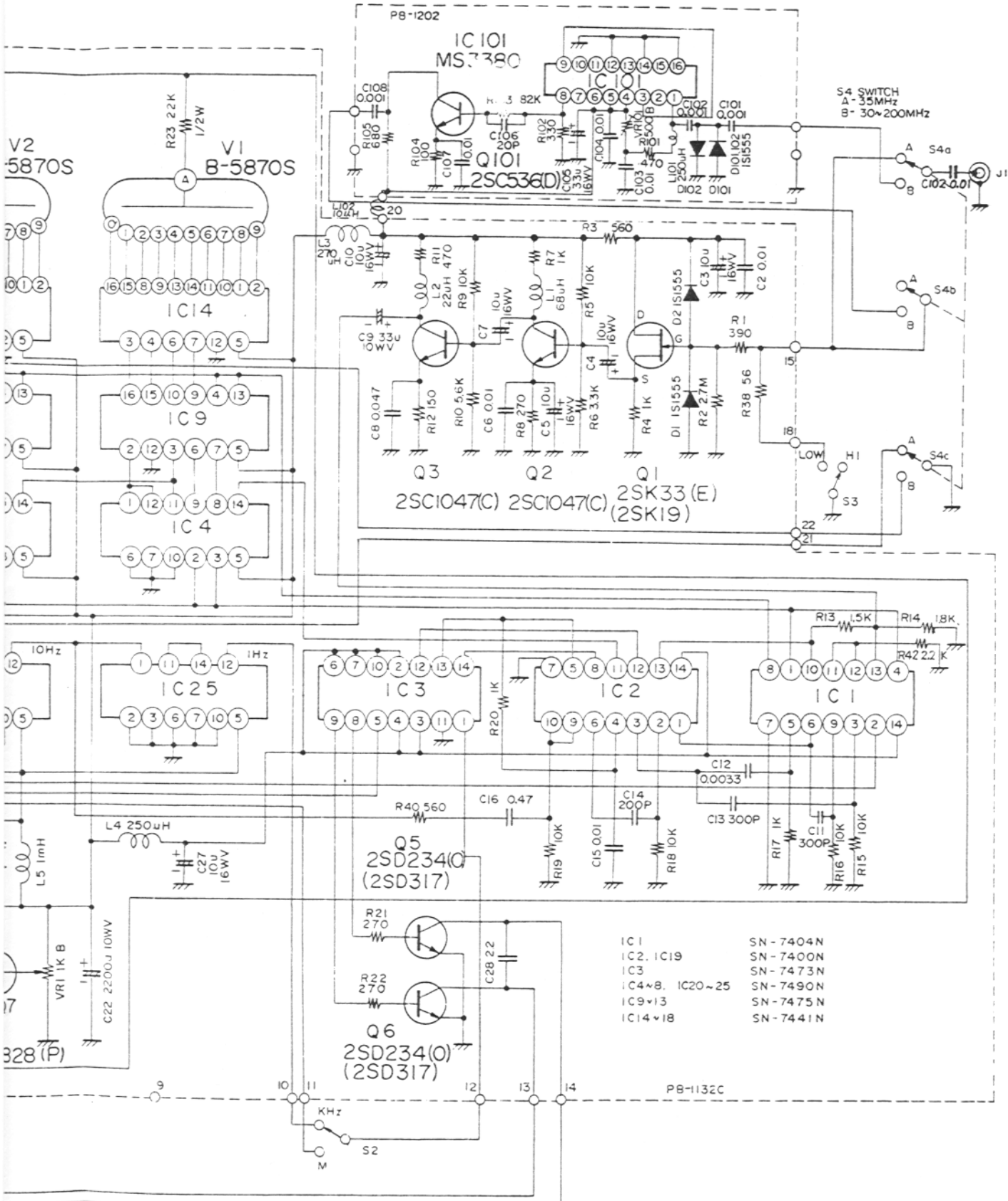

NOTES:
 1 ALL RESISTORS IN OHM 1/4W 10%
 UNLESS OTHERWISE NOTED.
 2 ALL CAPACITORS IN uF
 UNLESS OTHERWISE NOTED.

YC - 355D
 SCHEMATIC DIAGRAM

IC 1	SN - 7404N
IC 2, IC 19	SN - 7400N
IC 3	SN - 7473N
IC 4 * 8, IC 20 - 25	SN - 7490N
IC 9 * 13	SN - 7475N
IC 14 * 18	SN - 7441N